

# CHICAGO, MILWAUKEE AND SAINT PAUL SLEEPING AND OBSERVATION CAR KIT NUMBER HO-6

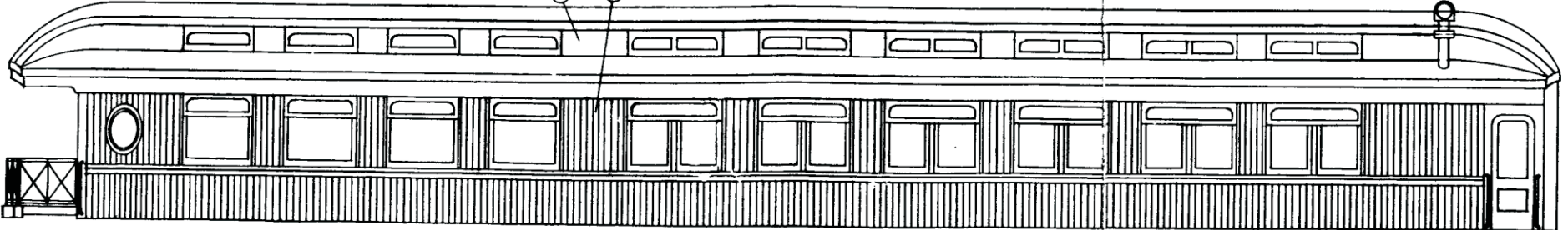

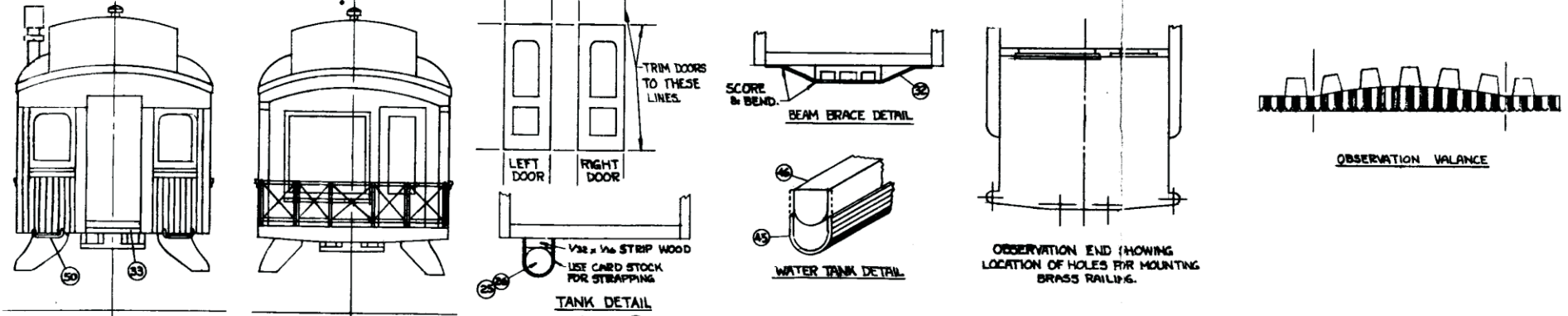
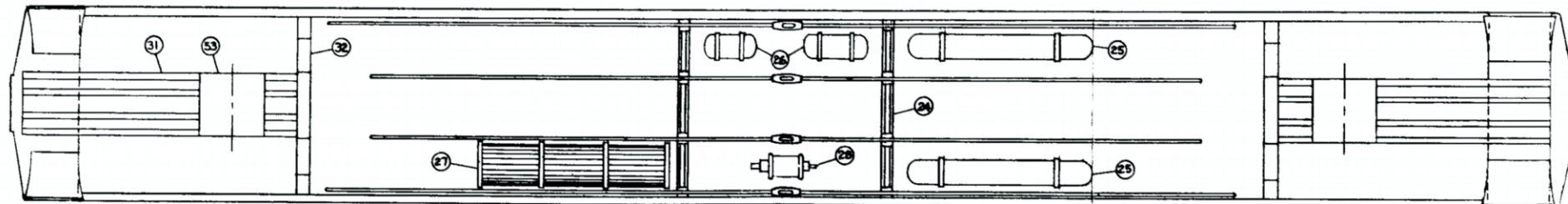
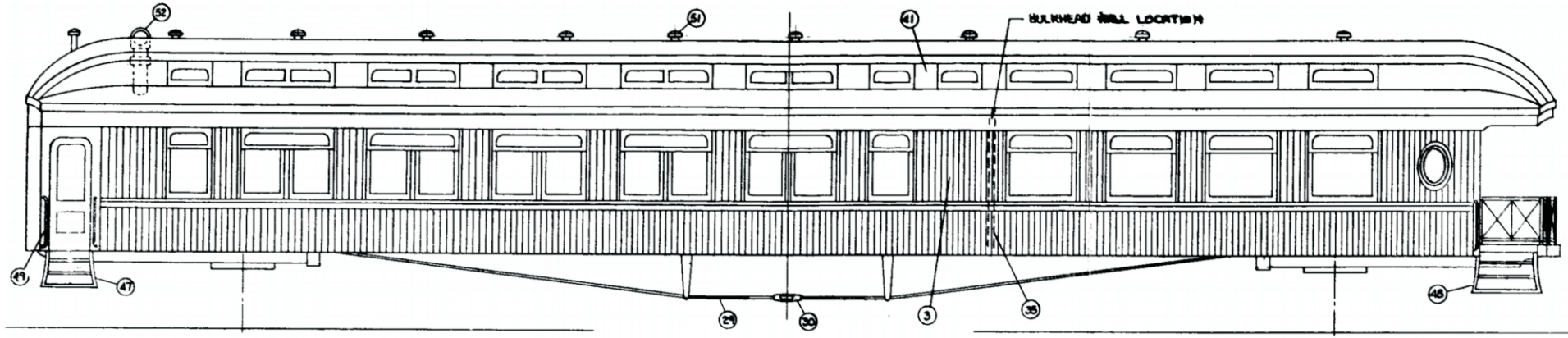
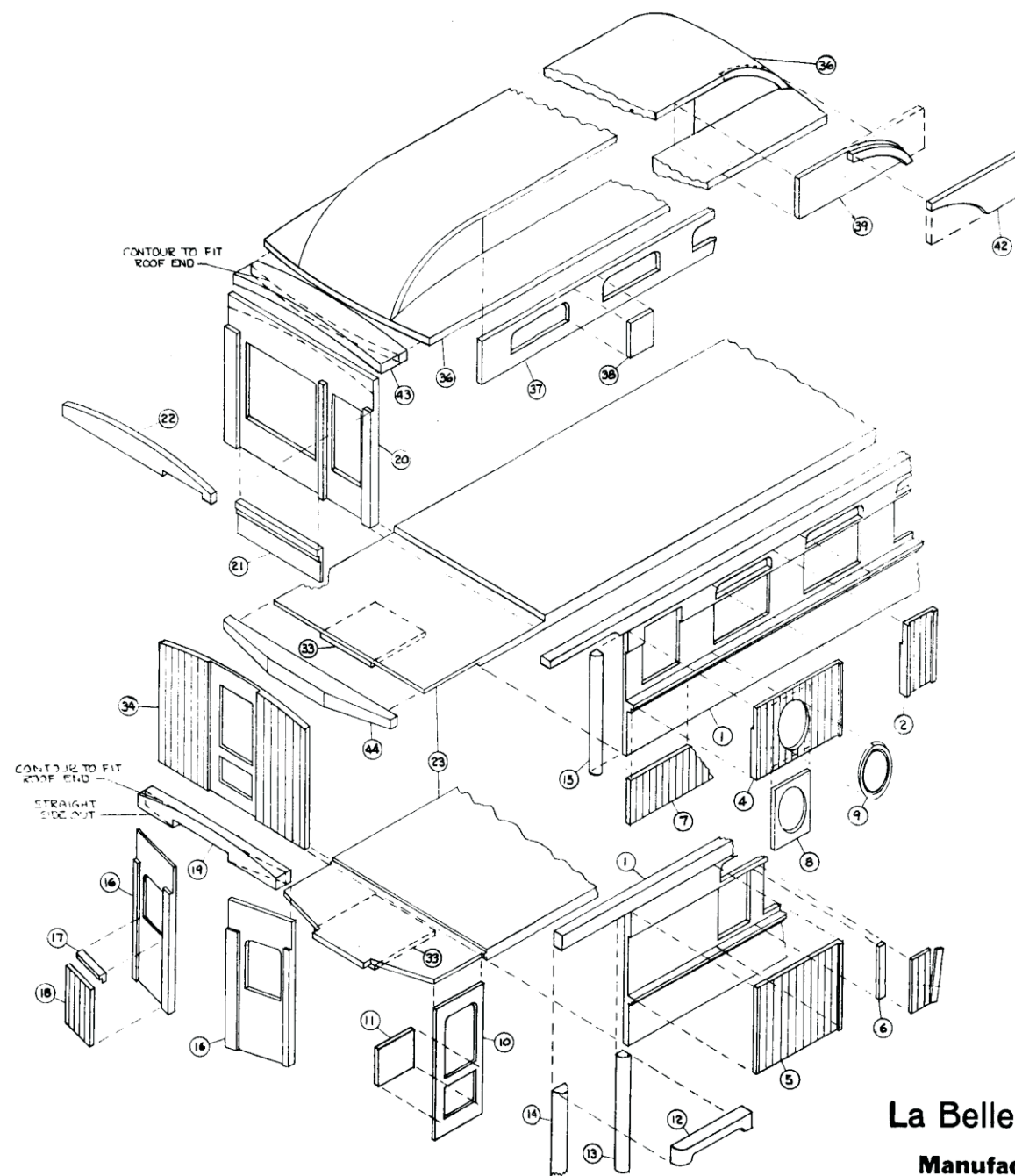

**Chicago,  
Milwaukee  
and  
St. Paul**

**Sleeping  
and  
Observation  
Car**

Built by  
**Barney & Smith**  
Dayton, Ohio, 1903

Original Color Scheme  
Orange Sides, Maroon Letterboard,  
Imitation Gold Lettering,  
Roof, Underbody Detail and  
Truck Black.

**La Belle Woodworking Company**

**Manufacturers of Model Railroad Kits**

P. O. BOX 22

CONOMOWOC, WISCONSIN

**KIT NUMBER HO-6**

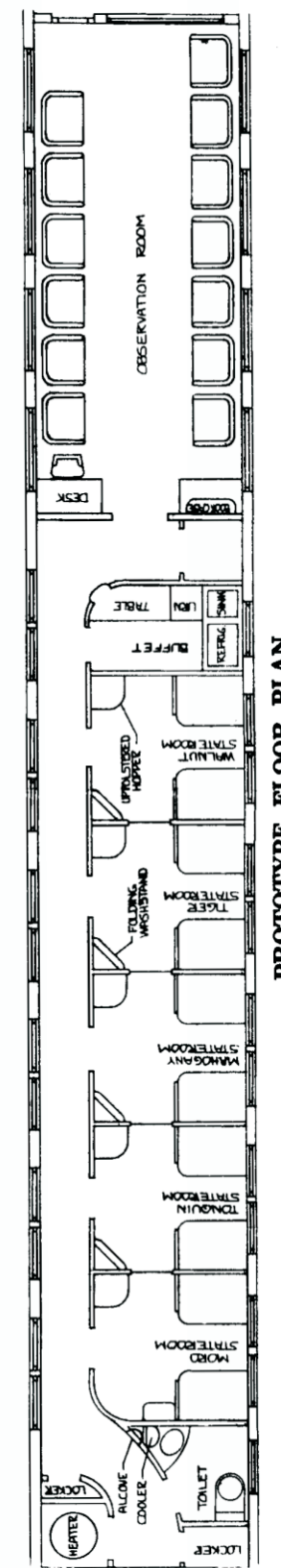

INSTRUCTIONS FOR ASSEMBLY OF  
1903 CHICAGO, MILWAUKEE AND SAINT PAUL OBSERVATION SLEEPING CAR



This is a basic kit of an early 1900 Observation Sleeping Car. It is not a "QUICKIE KIT" and therefore it is suggested that the isometric and plan drawings be studied thoroughly, also that the parts be sorted and be noted as to where they are intended to be used. It is suggested that assembly be followed by the numbers in the instructions which correspond with the numbers on the isometric and plan drawings.

**Caution:** Package marked "FRAGILE" should be handled with great care. Caution These are the sub-sides (1)

**NOTE:** All posts and offset scribed siding pieces for use between letterboard and belt rail (packed in package marked "Fragile") are cut to CORRECT HEIGHT.

Narrow window posts (2) are made from multiple post strip with (offset on back side).

Separate and cement in correct place.

Intermediate width window post (3) are made from multiple post strip with (offset on back side). Separate and cement in correct place on respective sides.

Cut scribed siding (4) with (offset on back side) and (Oval cutout) to correct width as shown on Side Elevations at Observation ends. Cement in place.

Cut scribed siding (5) with (offset on back side) and (no cutout) to correct width as shown on Side Elevations at Vestibule ends. Cement in correct place on respective sides. Cut 7/8 inch by 1 inch paper thin piece of scribed stock (6) to fit on small window posts. Separate to form eleven pieces as shown. Cement in place. Cement scribed siding (7) below belt rail. Trim flush with ends of sub-side (1).

Cut two Oval window inserts (8) from strip with oval cutouts to fit in square openings on back of sub-sides (1) at Observation ends. These are to finish off the back side of the subsides (1) at the Observation end, and to hold the GREEN acetate for the oval windows. **IMPORTANT:** Make sure oval opening aligns with oval openings in scribed siding. **DO NOT:** cement in place yet, but lay aside until later.

Cement oval Window Castings (9) in scribed siding with (Oval cutout) at Observation ends.

Cut two doors (10) to size by placing doors over templates on plan drawing, making sure that one right and one left are made and used on their respective sides. Cut panels (11) from 1/32 inch by 5 1/2 inch stripwood, furnished, and cement on back of doors as shown. Now cement doors to back of sub-sides at TOP ONLY. Slightly round vestibule door headers (12) to match door posts (13) 1/32 inch by 1/16 inch quarter round and door post (14) 1/16 inch by 1/16 inch half round. Cut to fit and cement in place.

Cut 3/64 inch by 5/64 inch quarter round (15) to length and cement in place at Observation end, as shown.

Make up two end pieces (16) by cutting belt rail (17) to fit as shown, making sure correct margin is kept below window when cementing in place. Next cut and fit thin 3/8 inch by 2 inch scribed siding (18). Cement in place. Now cement a completed right (16) and left (16) to end letterboard (19), making sure that wide offset of (16) is to center, as shown.

Make up Observation end wall (20) by cutting panel stock (21) to fit as shown below large window. Cement in place making sure piece is flush with bottom of Observation end wall. Now cement Observation end wall Header (22) to top of Observation end wall, making sure there is a slight projection on each side. Trim end wall (20) to contour of header (22) as shown.

Layout bottom of floor (23) for position of queen posts (24), pintsch gas tanks (25), air tanks (26), water tank (27), brake cylinder (28), truss rods (29), turnbuckles (30), beams (31) and beam braces (32). Cut beam filler pieces (33) from 7/16 inch by 1 inch stripwood, furnished for Observation and Vestibule ends, as shown. Make sure pieces are centered. Cement in place. After cement has set, sand pieces flush with bottom of floor if need be. Now cement beams (31) on top of beam filler pieces as shown. Cut, score and cement on 1/64 inch by 1/8 inch stripwood beam brace (32) furnished, in place, leaving other underbody parts off until car body is assembled.

Cement Vestibule bulkhead wall (34), Partition wall (35), and Observation end wall (20) to floor as shown, making sure they are square. Now cement completed sides to floor making sure that sides are flush with bottom of floor. Now set car body aside.

Start to assemble roof (36) by cementing clerestory window inserts (37) inside roof on each side. **IMPORTANT:** Make sure clerestory window inserts (37) are placed on correct sides of roof (TO MATCH CAR SIDES).

Cut to length roof window casing (38), (39) and (40), (41) from 1/32 inch by 3/16 inch stripwood, furnished, and cement in place. Now roof ends may be rounded to contour shown on plan drawing. Make template from card stock and use to check contour for correct shape. CARE should be taken when sanding roof ends to size, so as not to sand off too much. Make up overhang pieces (42) for ends of roof from 1/16 inch by 1/2 inch stripwood, furnished, as shown and cement in place.

Apply cement to end of floor and bottom of Vestibule end assembly. Temporarily place roof on car body, holding Vestibule end assembly up underroof contour and against end of floor until cement has set. Remove roof and apply small fillet of cement inside where Vestibule end meets vestibule doors. After end assembly has set, apply 1/32 inch by 1/16 inch quarter round door post (13) and 1/16 inch by 1/16 inch half round door post (14) on Vestibule doors as shown. Replace roof on car body and cement in place Observation end letterboard (43) by holding observation end letterboard up under contour of roof. When end letterboard (43) is in correct position, remove roof and put under pressure with rubber band until cement is set.

**CAUTION:** Extreme care should be taken when sanding this end letterboard to size. Cement on Observation End Sill (44) as shown, first spotting holes for Observation Platform Railing. **NOTE:** It is suggested that these holes be made with a small pin or point of a divider. The railing need not be cemented in place, but the small projections on bottom of railing may be pushed down into holes.

Make up water tank (27) by soaking 7/8 inch by 1-7/16 inch scribed tank wrapper (45) in hot water, placing it around water tank form (46) and holding in place with rubber bands until dry. Now cement water tank wrapper around water tank form (46). After cement has set, sand top and ends flush. Cement in place.

Make up and apply two gas tanks (25), and two air tanks (26) as shown. Cement on queen posts (24), Brake cylinder (28), in-stall truss rods (29) and turnbuckles (30).

Install steps (47) and (48) by filing off small taper on top edge at sides, so that sides are straight and same width as small tab. They should then fit into small rabbet on floor on both vestibule and Observation ends. Cement in place.

Make up handrails (49) and install. Add grab irons (50), roof vents (brass escutcheon pins) (51) and Chimney (52).

Car is ready for painting. Also paint oval window inserts (8). After painting, add Green acetate for clerestory windows in roof, upper windows on sides and Observation Oval windows. Clear acetate for lower windows. Don't forget to frost lavatory glass by sanding lightly on backside with fine sandpaper. Now cement oval window insert (8) in place. Attach Diaphragm, Observation Railing and Observation Valance.

**NOTE:** Position of truck centers will be determined by type make of trucks used. Position Bolster (53) accordingly.

## More Fun Modeling

AT ITS BEST . . . BUILD A LA BELLE ALL WOOD KIT  
"EXCLUSIVE"  
WITH REALISM

One piece hollow-milled roof with clerestory window inserts.  
All precision basswood parts made by La Belle Woodworking Co.

Here's the construction kits you model builders have waited for. All basswood precision parts, pre-cut window detail, scribed sides, die-cast steps, underbody detail, diaphragms, and easy-to-follow instructions. Complete kit, less trucks and couplers.

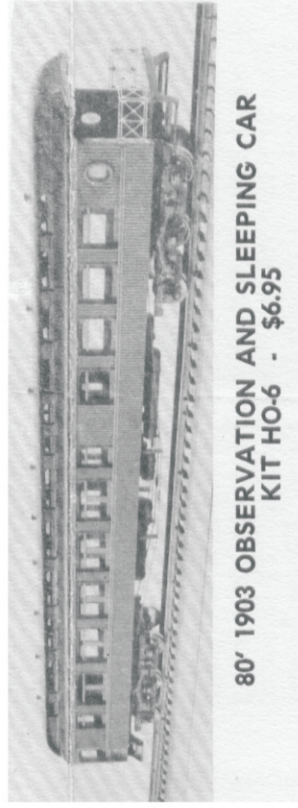

80' 1903 OBSERVATION AND SLEEPING CAR  
KIT HO-6 - \$6.95

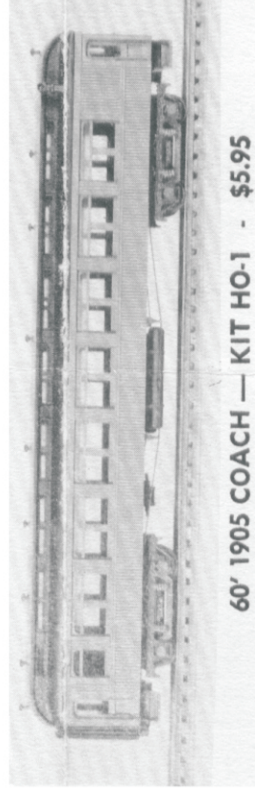

60' 1905 COACH — KIT HO-1 - \$5.95

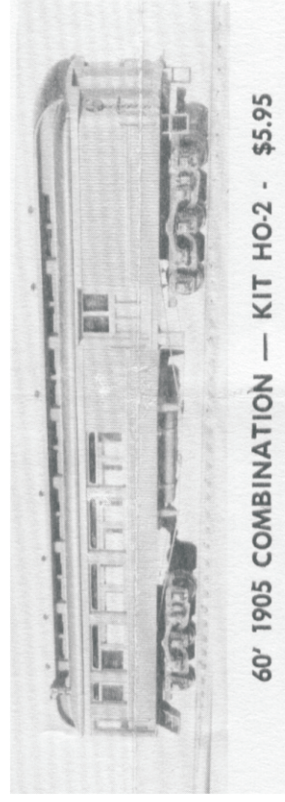

60' 1905 COMBINATION — KIT HO-2 - \$5.95

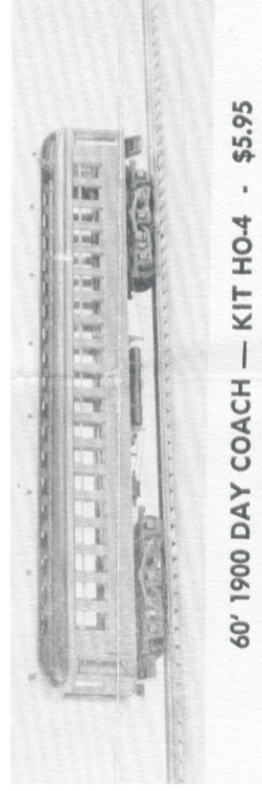

60' 1900 DAY COACH — KIT HO-4 - \$5.95

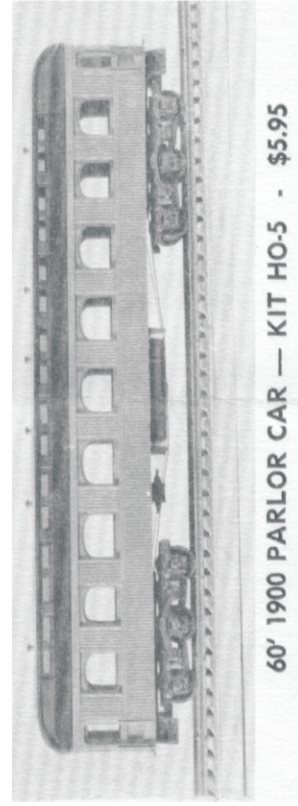

60' 1900 PARLOR CAR — KIT HO-5 - \$5.95

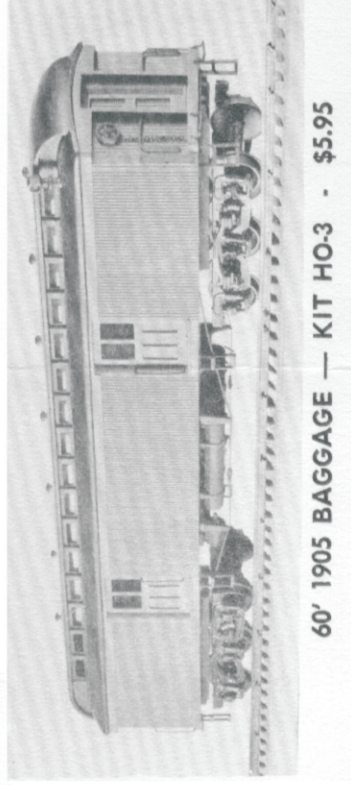

60' 1905 BAGGAGE — KIT HO-3 - \$5.95

Note: These prices were current for the 1960's and are presented on this page as part of the original HO-6 Instructions.  
See our web site at [www.labellemodels.com](http://www.labellemodels.com) for current pricing

Watch our Ad in Model Railroader for New Kits as they become available. — See Your Dealer First - If not available order direct

LA BELLE WOODWORKING COMPANY

OX 22

• OCONOMOWOC, WISCONSIN 53066